

Feel the difference

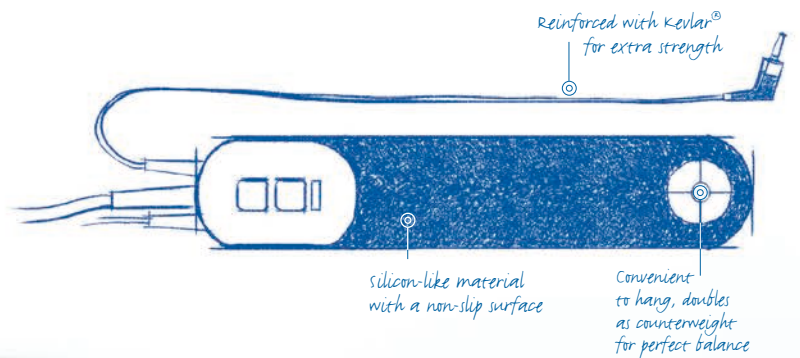

MADSEN® Zodiac

Control, confidence and efficiency
in immittance testing



otometrics

successful immittance testing begins with you

and MADSEN Zodiac



MADSEN® Zodiac is an immittance testing solution from Otometrics. Built from the ground up with hearing care professionals just like you, MADSEN Zodiac delivers the control, confidence and efficiency you need for successful immittance testing.

MADSEN Zodiac is designed with focus on the probes and the way you work, whether you are performing routine tympanograms or more advanced testing. It is reliable, responsive and easy to use. You stay focused on your patients, boost testing efficiency and increase testing success. MADSEN Zodiac is suitable for use with both children and adults.

MADSEN Zodiac is available in three versions:

- Quick Check
- Diagnostic
- Clinical

Each version is available as stand-alone and PC-based. Find out more on page 12.

Feel the difference. Pick up a probe and start working. It really is that easy. Contact your local Otometrics representative for a demonstration.

Or, visit www.otometrics.com/zodiac for more information.



An easier way to a reliable seal

A successful immittance test depends on getting and keeping a reliable seal. However, even with the most sophisticated systems and probes, getting a seal can be an elusive and frustrating process.



There are three probes available – Quick Check for screening and Classic or Comfort diagnostic probes for more advanced testing. Each probe has a unique design for easier, faster and more stable placement. The diagnostic probes are exceptionally lightweight – they are half the weight of regular probes. This ensures quick sealing, maximum control and reliable results.

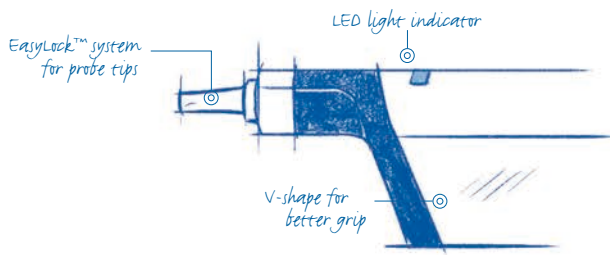

Some of our customers pick up a probe like a pen, and others like a TV remote. So, we designed our Quick Check probe to be comfortable to hold in either position.

Thomas Geertsen
Mechanical Engineer

MADSEN® Zodiac removes the guesswork in immittance testing. Ergonomic, responsive probes feel natural in your hands. You can hold them in the way that works best for you to make it easier to place the probe and feel the seal. You know immediately when

to begin testing. Light indicators on the probes and shoulder pad tell you which ear you are testing, and the status of the test. Audio feedback and the probe light indicators quickly alert you if you lose the seal. And, if you lose the seal, the pump resets instantly, minimizing disruption to your test.

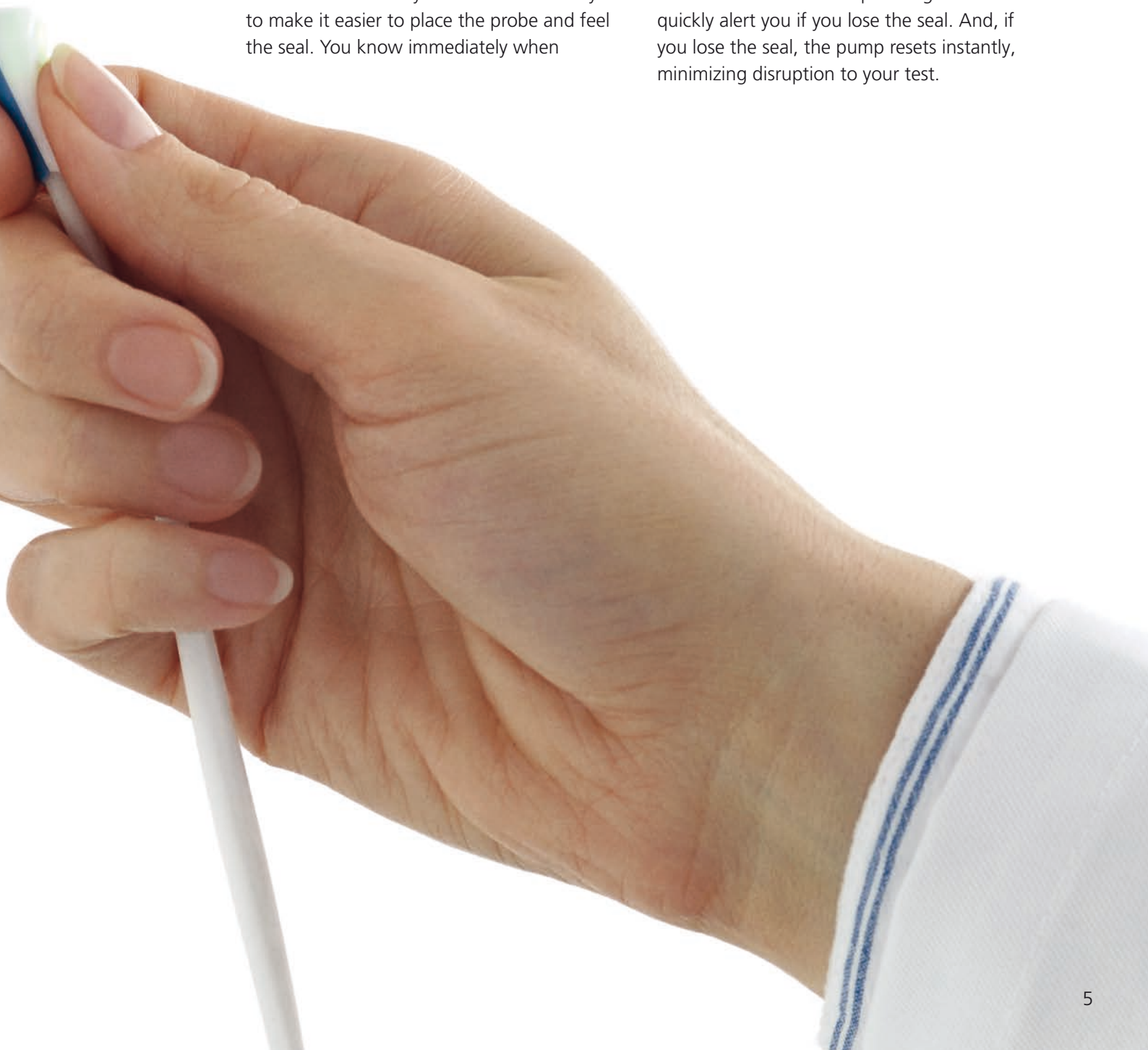

Focus on your patients and achieve better outcomes

MADSEN® Zodiac makes immittance testing easier by removing the barriers that disrupt your workflow and concentration. Unique features help you stay focused on your patients and make the most of your professional skills.

Remote control buttons make it possible to stop and start tests and change ears whenever you want – without walking to and from the device. Long, sturdy cables allow you to move around freely and get closer to your patient. The comfortable no-slip shoulder strap stays put.

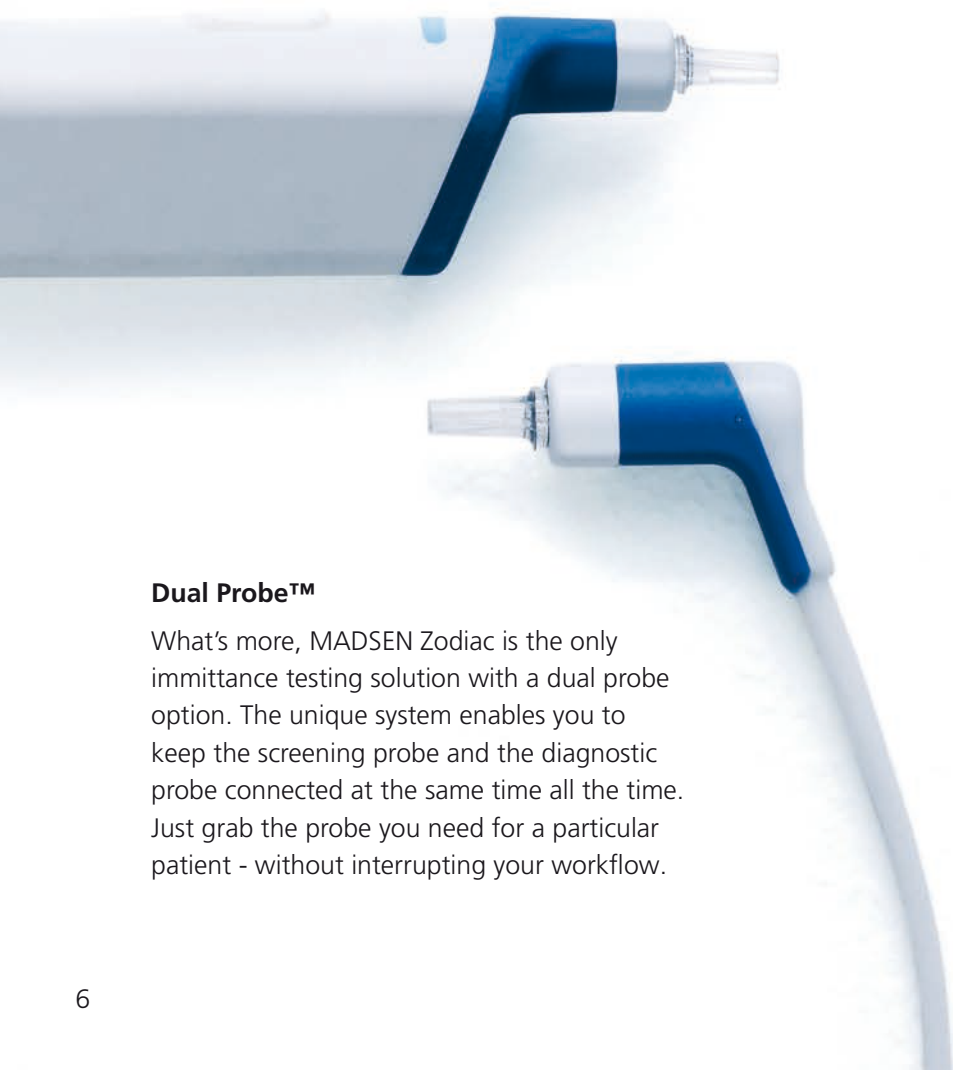

Dual Probe™

What's more, MADSEN Zodiac is the only immittance testing solution with a dual probe option. The unique system enables you to keep the screening probe and the diagnostic probe connected at the same time all the time. Just grab the probe you need for a particular patient - without interrupting your workflow.



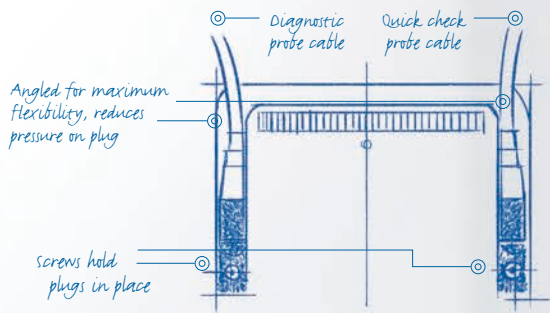

After talking with clinicians, we learned how frustrating it is to have only one probe type when you are performing all types of immittance testing. That's why we developed the Dual Probe™ option. It's ideal for clinics that need both routine quick tympanometry and diagnostic capabilities.

Johannes Lantz
Audiologist



Thumb 'push' design is one of two choices for diagnostic probe

silicone-like shoulder strap for better grip, flexibility and cleanability

Detachable control pad for easy cleaning of strap

Diagnostic probe weight halved

Kevlar-reinforced for extra strength

- Control tests and
- Responsive audio

Fast built-in printer with no-hassle paper change

Internal test cavity

Robust pump responds quickly

Dual Probe™ option



MADSEN® Zodiac

ear switch remotely and light feedback

EasyLock™ system for quick probe tip change

Inexpensive and transparent probe tips

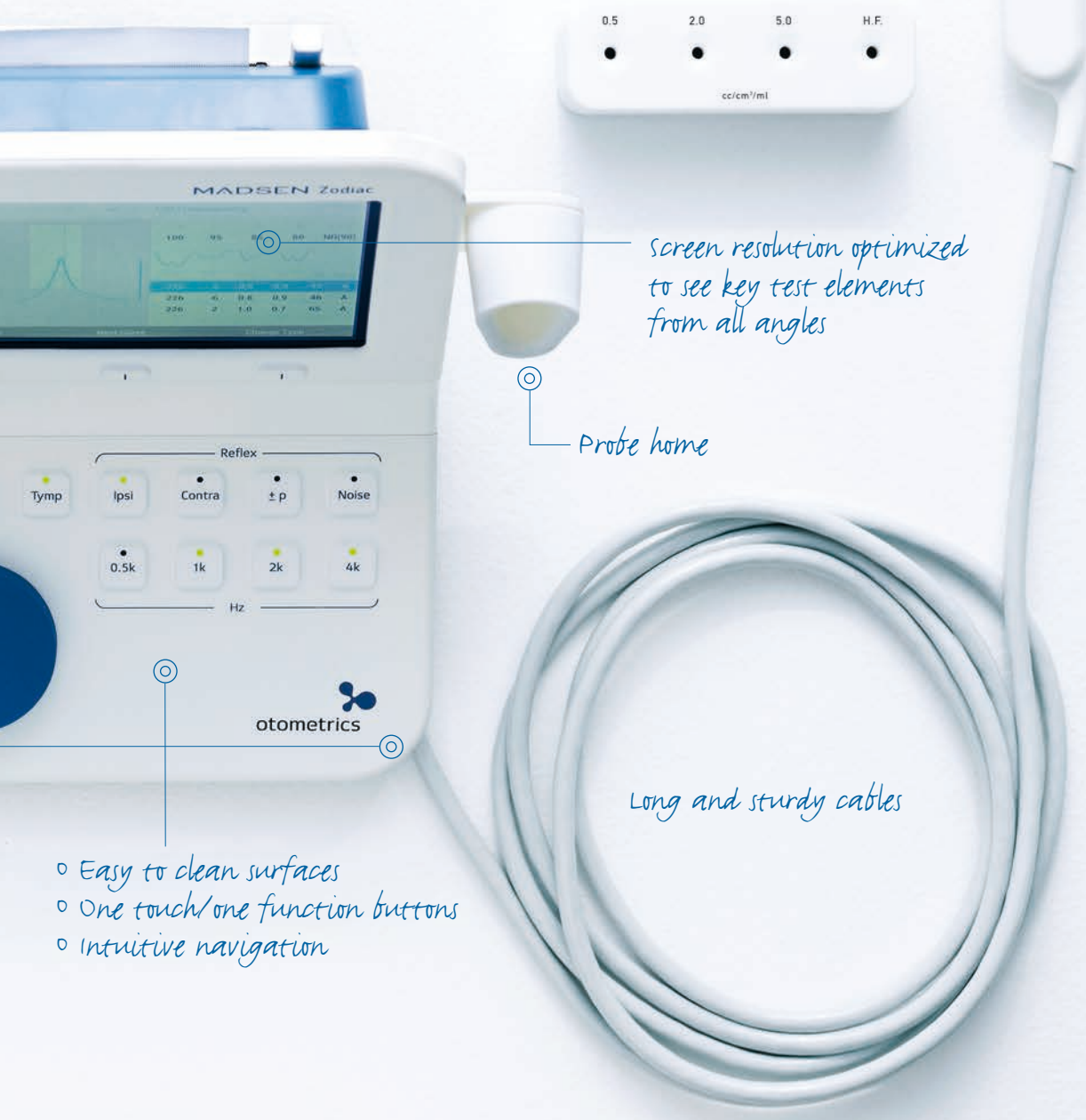

screen resolution optimized to see key test elements from all angles

Probe home

Long and sturdy cables

- Easy to clean surfaces
- One touch/one function buttons
- Intuitive navigation

Making every step easier

MADSEN® Zodiac streamlines immittance screening and testing. Whether you choose the PC-based or stand-alone version, MADSEN Zodiac is simple to use. Just walk up and start testing – it really is that easy and intuitive.

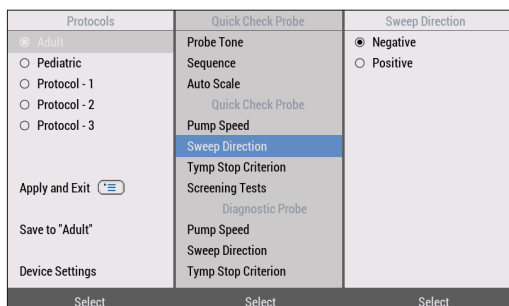

A flat menu structure and self-explanatory OTOSuite® software mean you can find exactly what you need quickly – without getting lost in the system.

The stand-alone version has a sleek front panel with one touch/one function buttons that give you direct access to common tests, such as tympanometry, reflex, ipsi and contra.



The compact stand-alone solution is sturdy – yet elegant. It has a wide, color screen. The design of the 7 inch screen means you can see tests results clearly from any angle. Clear-cut display resolution and low reflection provide high visibility. The key graph elements of the curve, peak and normative area stand out on the screen – even from a distance.

It was after a quick demo for an audiologist that I realized just how easy Zodiac is to use. The audiologist called a colleague over to see the system. Instead of asking me to repeat my demonstration, the audiologist was able to demo the system herself with no problem.

Clément Sanchez
Audiologist and Product Manager

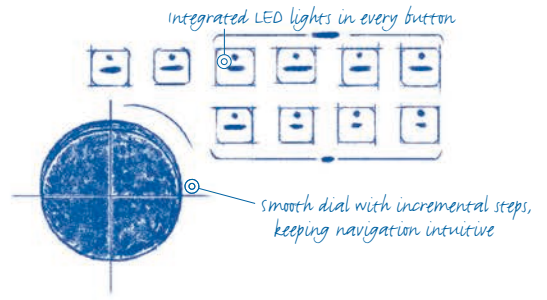

Print test results and reports quickly with the built-in printer. The paper roll is amazingly simple to change. The OTOSuite software gives you the freedom to choose more printing options.



MADSEN Zodiac is designed to meet the strict hygiene requirements of today's hospitals and clinics and helps to promote infection control. For example, all surfaces are easy to clean. Even the buttons are sealed, so there are no cracks where dirt and debris can accumulate. Change the inexpensive probe tips quickly – and as often as you like – with the EasyLock™ system.

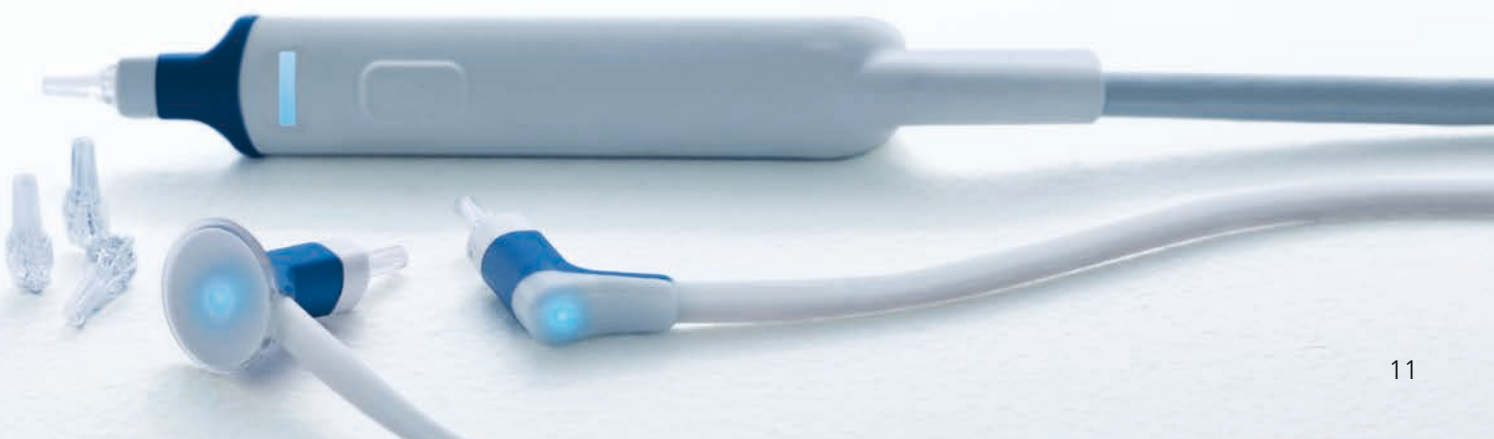

Choose the solution that works for you

MADSEN® Zodiac is available in three versions: Quick Check, Diagnostic and Clinical.

Quick Check



Stand-alone



PC-based

Diagnostic / Clinical



Stand-alone



PC-based

All three versions are available as stand-alone and PC-based solutions optimized for touch screen.

Test more patients every day

MADSEN Zodiac Quick Check makes tympanometry and reflex screening more efficient. A clean and simple design dedicated for screening has only the buttons and essential tests you need. Remote controls on the probe allow you to switch ears directly from the probe. Read and document the test results quickly using the built-in printer and save the results in OTOSuite®. Remove or export as a pdf file.

Perform comprehensive immittance testing

MADSEN Zodiac Diagnostic and Clinical solutions offer a comprehensive battery of immittance tests and additional tests for more extensive testing and research. Flexible setup options enable you to change to manual pressure control for advanced testing, and you can also change the settings to suit your workflow and needs. Use the dual probe feature to switch from the Diagnostic probe to the Quick Check probe at any time – without interrupting your workflow.

	Quick Check	Diagnostic	Clinical
Sweep/auto tympanometry	⊙	⊙	⊙
Manual tympanometry		⊙	⊙
226 Hz probe tone	⊙	⊙	⊙
1000 Hz probe tone		⊙	⊙
678 and 800 Hz probe tones			⊙
Reflex Screening	⊙	⊙	⊙
Reflex Threshold (ipsi/contra)		⊙	⊙
Reflex Decay		⊙	⊙
ETF-P			⊙
Admittance Recorder			⊙
B&G tympanograms			⊙

MADSEN Zodiac and OTOSuite ...a perfect match

The MADSEN® Zodiac workflow is based on OTOSuite® software – the shared interface for all Otometrics hearing assessment and fitting solutions. OTOSuite makes testing and data management more efficient, accurate and convenient.

The dedicated OTOSuite immittance module is easy to learn and use. It can be customized to suit individual needs or you can standardize protocols across larger organizations. OTOSuite is even optimized for touch screen so that you can control your immittance testing from the screen of your choice.

OTOSuite REPORTS

With OTOSuite, you can create consistent and professional reports – unique to your clinic. OTOSuite REPORTS delivers powerful reporting capabilities and easy customization tools that enable you to design and share the reports you need quickly. OTOSuite REPORTS combines and uses data from one or more of your Otometrics devices so you can create your own standardized reports. Included is concurrent report functionality that instantly fills in data as you complete each step, so it's possible to have an instant overview of your testing process and a finished report at the end of every test. And if you use OTObase®, the Otometrics database, it is also possible to create standardized reports using data from all your devices – regardless of manufacturer.





MADSEN® Zodiac
Immittance



AURICAL® OT0cam 300
Video otoscopy



MADSEN® Capella²
OAE



MADSEN® Astera²
Clinical audiometry

OTOsuite keeps everything you need for the entire patient journey in one place allowing you to work with your audiometer, OAE, video otoscope and immittance devices in one shared interface. It integrates seamlessly with Noah and external Electronic Medical Records (EMR). You can easily and safely transfer data to selected patient files, reducing errors – saving you time every day.



Innovative immittance testing since 1961

Otometrics has driven immittance innovation for over 50 years. Poul Madsen launched the world's first commercially available electro-acoustic impedance bridge in 1961. MADSEN® Zodiac is our latest solution that helps our customers succeed in improving the quality of life for their patients.

About Otometrics

Otometrics is the audiology industry leader providing instrumentation and software solutions to hearing and balance care professionals worldwide. With more than 500 employees and offices in 34 countries, we help our customers succeed in improving the quality of life for millions of people by delivering expert knowledge, reliable solutions and trusted partnership. For more information, please visit www.otometrics.com

GN Otometrics A/S, Headquarters. +45 45 75 55 55. info-dk@gnotometrics.com
GN Otometrics, North America. 1-800-289-2150. sales@gnotometrics.com
www.otometrics.com



otometrics